

CHAPTER XII

AEROPULSE

1. Compressorless Thermojets

In the previous chapters, we have studied the solid and the liquid propellant rocket. It is seen that the specific propellant consumption of these rocket units is quite high. Although, due to the extremely light weight of the power plant, the rockets are well adapted to short duration propulsion, efforts must be made to reduce the propellant consumption for longer durations of operation. The rocket power plant carries its own oxygen for combustion, either in a single chemical compound with the fuel such as nitromethane, or in a separate compound such as nitric acid. Since there is abundant oxygen in the atmosphere, the logical way to reduce propellant consumption is to utilize the atmospheric air to support the necessary combustion in a propulsive system.

However, the only way heat energy can be converted into kinetic energy, and hence propulsive thrust, is by expanding the combustion product from a pressure higher than atmospheric to atmospheric pressure. Thus, in order to obtain effective thrust, we must devise means to produce this hot combustion product at high pressure. There are two simple methods of achieving this. One is to utilize the high kinetic energy of the air stream relative to a rapidly moving aircraft. This kinetic energy is converted into pressure energy by a diffuser. The air at the higher pressure is then fed into the combustion chamber where fuel is injected. In the combustion chamber, the gas is heated and accelerated. Additional velocity could be achieved by expansion through the exhaust nozzle to the prevailing ambient pressure. This type of power plant is called the ramjet (athodyd). The second method of obtaining the high combustion pressure is to carry out the combustion at constant volume. In this type of propulsive system, the air is sucked into the combustion chamber, the chamber is closed and fuel added. The combustion at constant volume produces an end pressure many times the pressure in the chamber at the beginning of combustion. Then the combustion chamber is again opened and the products of combustion expand through the exhaust nozzle. The operation is thus cyclic and the thrust is intermittent. Thus it is called the aeropulse (impulsive duct). Both ramjet and aeropulse achieve high combustion pressure without the aid of a mechanical compressor and are designated as thermojets without compressors or simply as compressorless thermojets.

The idea of ramjet or aeropulse is certainly not new, as it has appeared frequently in patent literature. For instance, the ramjet was studied by M. Roy, G. A. Crocco, L. Breguet, R. Devillers and L. Stipa*. A model of a ramjet-propelled airplane was exhibited by R. Leduc in one of the Paris aviation exhibitions (1933). Patents on aeropulse were issued to Schmidt (1930). Stipa also investigated the performance of the propulsive system,

*See footnote on next page

although his analysis is erroneous. All these investigations show that, at low speeds, the fuel consumption of compressorless thermojets is much higher than the conventional engine-propeller propulsive system. Thus, for long duration operation at low flying velocities, there is no reason to use compressorless thermojets even with the advantage of extremely light power plant weight obtained by simplified construction. With the recent interest in relatively short duration operation at high speeds, such as propulsion of transonic airplanes and flying bombs, it has been found that compressorless thermojets have many advantages over other propulsive units.

2. Aeropulse

The German aeropulse for the flying bombs is the first successful realization of this type of power plant. The general dimensions are given in Fig. 12.1. The air is sucked into the combustion chamber by the vacuum created by exhaust of the previous cycle. The intake air passes the venturi where gasoline is continuously injected. The explosion of the air fuel mixture raises the pressure in the combustion chamber to a high level and closes the spring valve at the intake. The gas is thus forced to expand through the exhaust duct and is discharged at high speed. This gives the propelling impulse. At the end of discharge, the inertia of the gas creates a vacuum in the combustion chamber and the engine is ready to start a new cycle again. The pressure in the combustion chamber is controlled by the rate of fuel injected and this in turn controls the discharge velocity of the gas and, thus, the propulsive thrust. To start the engine, a carefully adjusted amount of fuel is sprayed into the cold combustion chamber in order to create a mixture and the resultant strong explosion starts the cycle.

The fuel flow, injected directly into the combustion chamber, is continuous throughout the cycle with some variation in fuel flow resulting from the pressure in the combustion chamber. This fuel flow fluctuation can be neglected, however, since very high pressure nozzles, 150 psi, provide slightly better operation and fuel economy. The air flow, on the other hand, ceases to flow through the grill for approximately 50% of the cycle during the increased pressure resulting from combustion. During this time, then, an over-rich slow burning mixture forms in back of the grill around the fuel nozzles. As the high velocity discharge through the tail pipe depletes the burned gases, the momentum in the tail pipe plus the ram pressure cause a sudden inrush of charge air that mixes with the fuel as it passes the nozzle and venturi. At the exit from the venturi there is a sudden enlargement in

*Roy, M., Recherches theoretiques sur le rendement et les conditions de realisation des systemes motopropulseurs a reaction, Paris, 1930

Crocco, G.A., "Corpi aerodinamici a resistenza negativa". Rend. Acc. Lincei (6), Vol. 13, 1931, pp. 906-911; "Sui corpi aerotermodinamici portanti", Rend. Acc. Lincei, Vol. 14, 1931, pp. 161-166

Breguet, L. and Devillers, R., "L'Aviation superatmospherique des aerodynes propulses par reaction direct" La science aerienne, Vol. 5, 1936, pp 183-222

Stipa, L., "La propulsion des aeronefs par reaction" L'aerotechnique, Vol. 17, No. 191, November, 1938, pp. 141-149

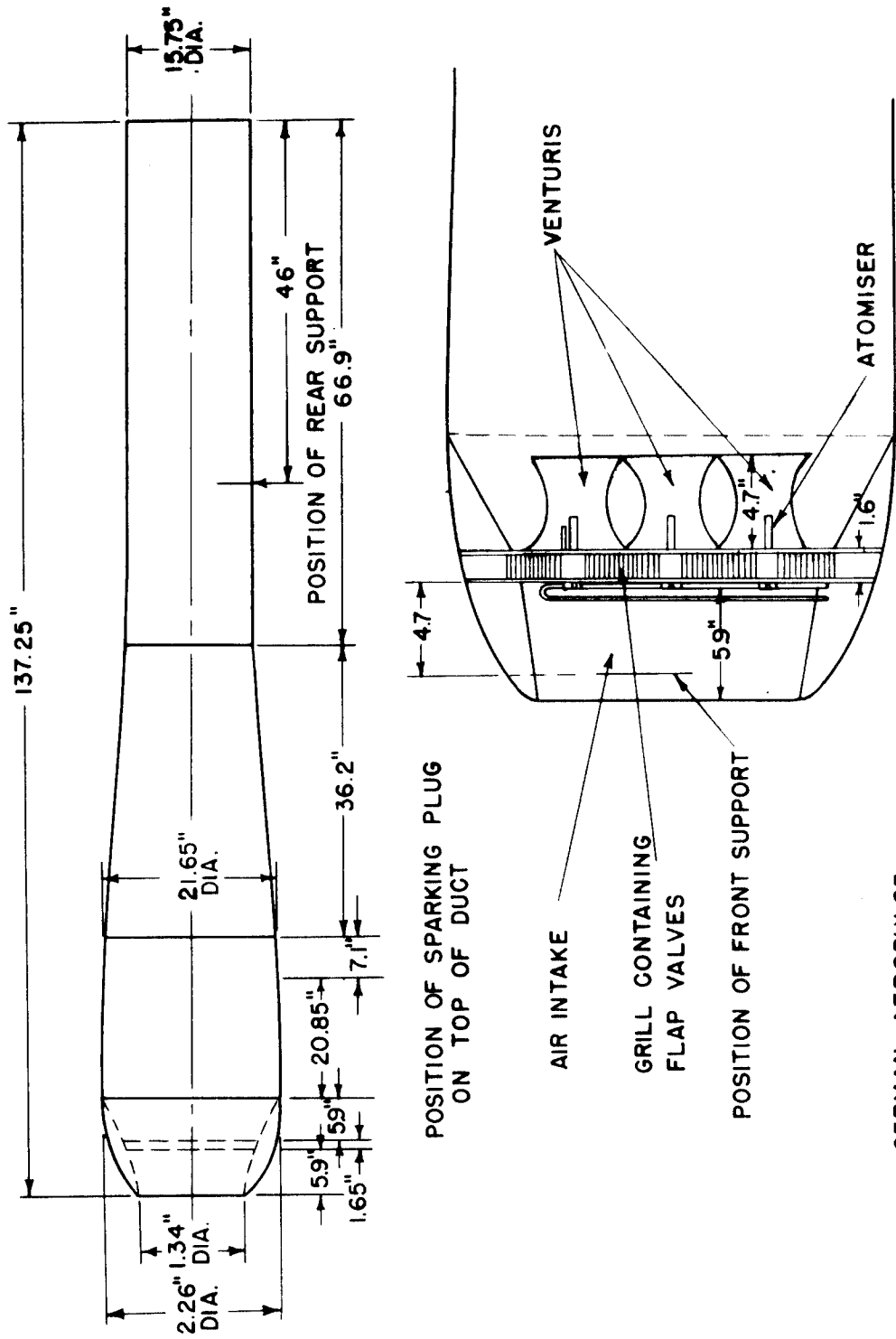

GERMAN AEROPULSE
GENERAL ARRANGEMENT OF DUCT

Fig. 12.1a

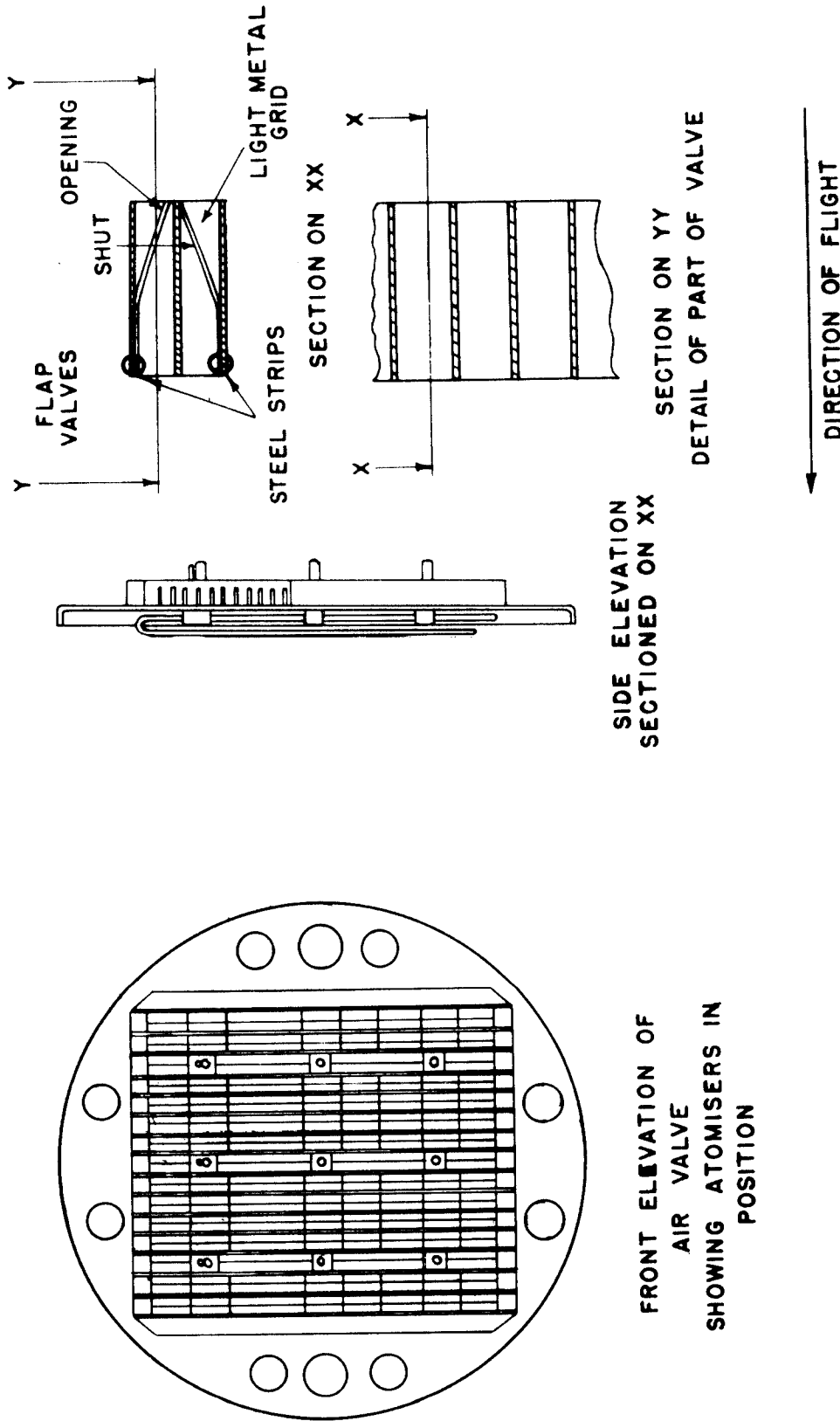

AIR VALVE
GERMAN AEROPULSE

Fig. 12.1b

the flow area to the full diameter of the combustion chamber. This forms eddy currents of the intruding charge towards the sides of the combustion chamber. Part of the over-rich slow burning residual mixture along with any residual hot burned gases is pushed and rolled along the sides of the combustion chamber. This ignites the new charge along the sides as well as at the entrance.

The flow in the combustion chamber and the discharge duct is thus a pulsating one with very large amplitude as shown by Figs. 12.2 and 12.3*. The correct analytical treatment of such flows would involve the knowledge of combustion under such conditions and the flow with traveling shock waves. Since this is too complicated, we shall limit ourselves to a simplified treatment which is believed to be a good representation of the actual conditions.

3. A Simple Theory for Aeropulse

Let the subscript 0 denote quantities corresponding to the free atmospheric conditions, the subscript 1 denotes stagnation conditions when the spring valves are closed, the subscript 2 denotes the conditions in the combustion chamber at the end of the charging process and the subscript 3 denotes the conditions at the end of combustion. Since the compression from free stream to the stagnation pressure is really the inverse of the isentropic expansion, the chamber conditions are now the stagnation conditions, and the exit conditions are now the free stream conditions. Thus we have from Eq. (1.55)

$$\frac{p_1}{p_0} = \left(1 + \frac{\gamma - 1}{2} M_0^2\right)^{\frac{\gamma}{\gamma - 1}} \quad (12.1)$$

The temperature ratio is then

$$\frac{T_1}{T_0} = 1 + \frac{\gamma - 1}{2} M_0^2 \quad (12.2)$$

When the spring valve is opened, there is a rush of air into the combustion chamber and the velocity in the throat of the venturi must be very close to the velocity of sound. In other words, the pressure at the throat is roughly one-half that of p_1 . Due to the bad diffuser shape, very little of the kinetic energy is recovered as pressure energy. Thus we can assume that

$$p_2 = \frac{1}{2} p_1 \quad (12.3)$$

The temperature T_2 , being a representation of the total energy of gas at

*This diagram is reproduced from Memorandum Report No. TSEPL-5-673-55, "Preliminary Testing of German Robot Bomb Engine", AAF, November, 1944. The pressure is measured by indicators uncompensated for their natural frequencies. These curves are thus more qualitative than quantitative.

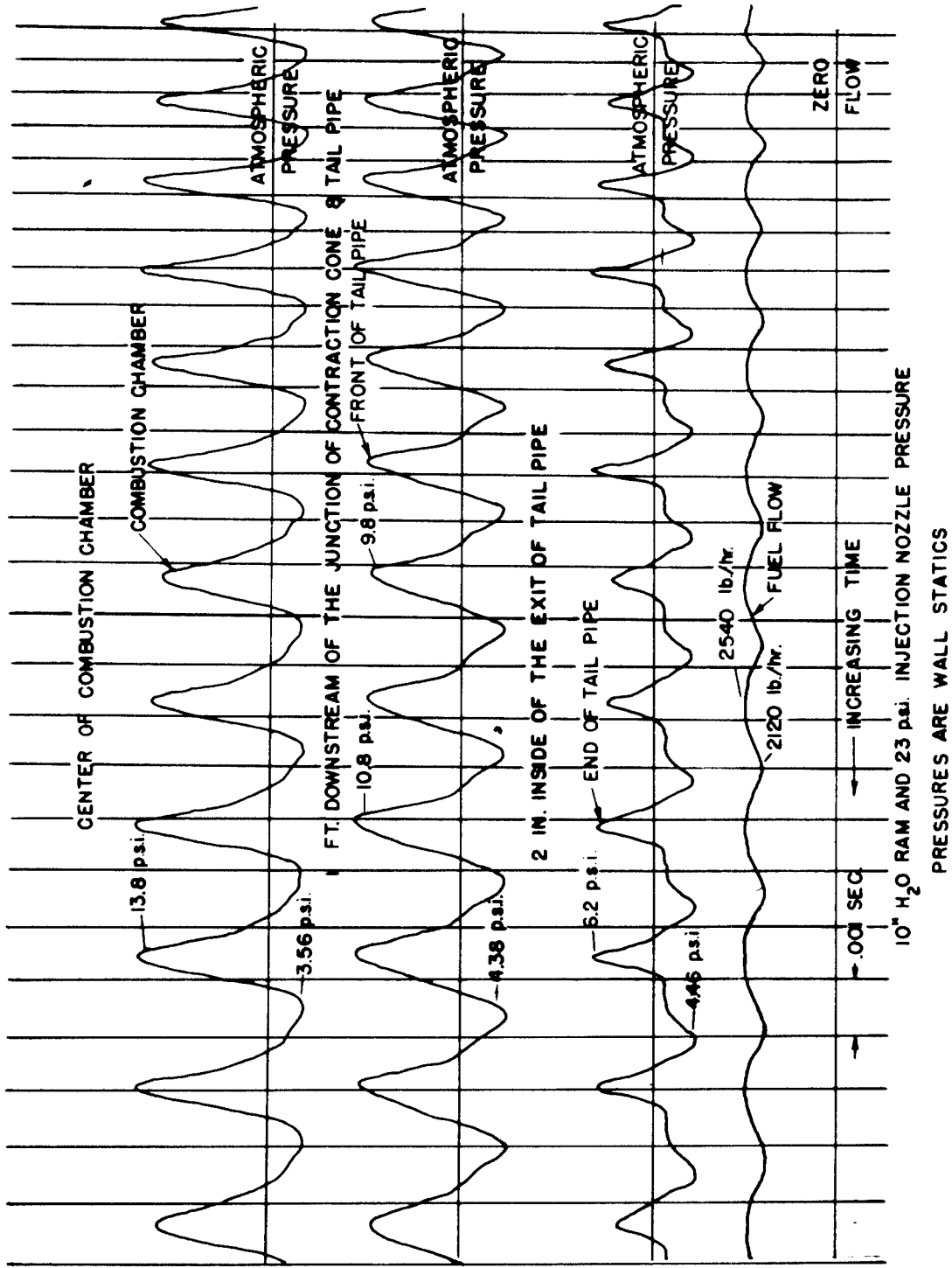

Fig. 12.2

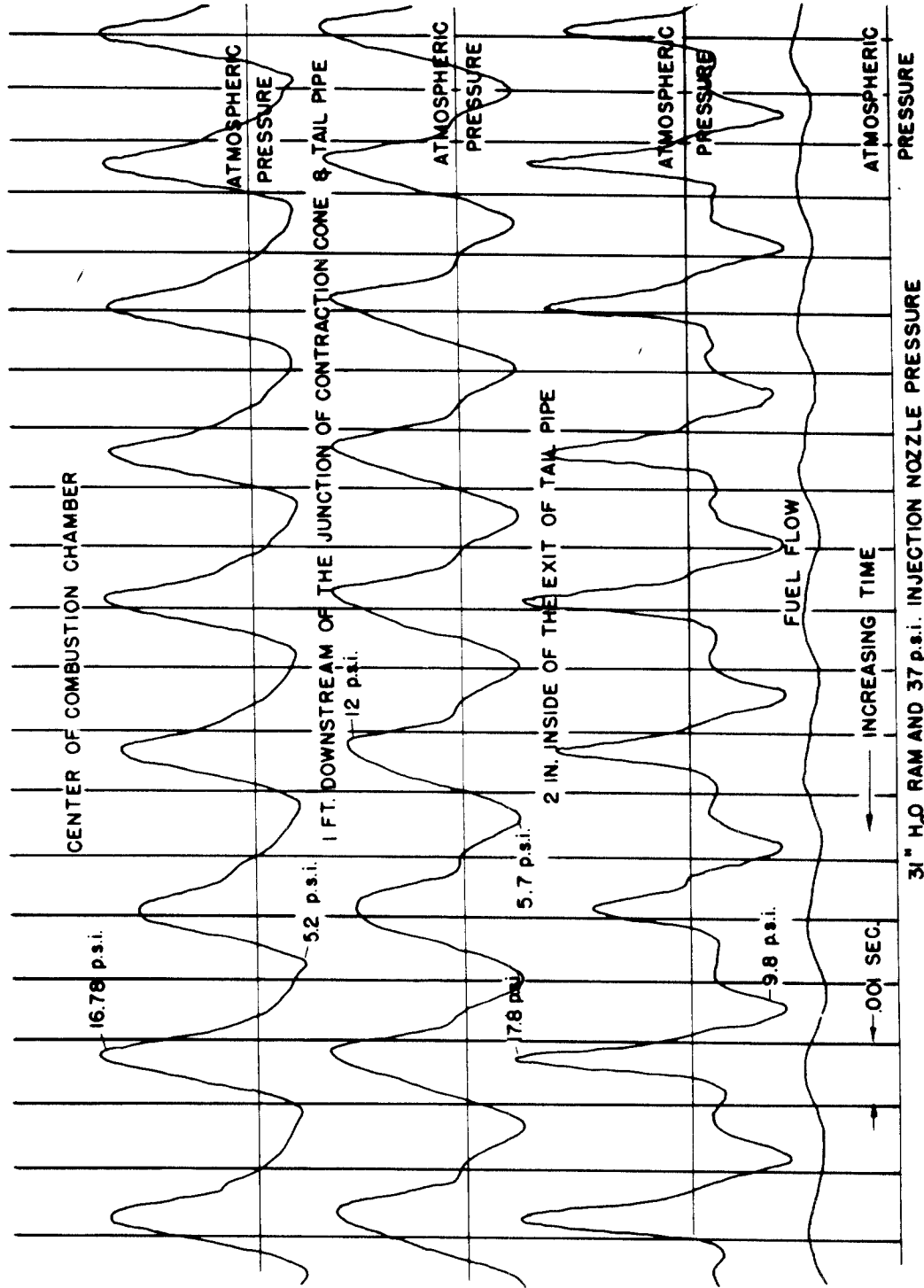

Fig. 12.3

rest, must be the same as T_1 , since no appreciable heat loss can occur.

$$T_2 = T_1 \quad (12.4)$$

It will be assumed that the combustion is carried out at constant volume. Thus, if the small additional fuel flow is neglected, the heat added h per unit mass of air is

$$h = C_v' (T_3 - T_2) = \frac{1}{\gamma'} C_p' T_3 \left(1 - \frac{T_2}{T_3} \right)$$

The prime quantities are referred to the combustion products. Since the combustion is carried out at constant volume,

$$\frac{T_2}{T_3} = \frac{p_2}{p_3} \quad (12.5)$$

Therefore

$$h = \frac{1}{\gamma'} C_p' T_3 \left(1 - \frac{p_2}{p_3} \right) \quad (12.6)$$

To calculate the discharge process, we assume that the velocity of discharge at every instant is the same as the isentropic steady expansion from the chamber pressure p to p_0 , the atmospheric pressure. Due to the removal of mass in the chamber, the pressure in the chamber will also drop. The expansion of gas in the chamber is also isentropic if heat loss to the atmosphere is not counted. This really corresponds to a physical situation of a very large chamber and a very small discharge nozzle so that the pressure variation in the chamber is very slow and a steady discharge is approximated. We shall calculate the total impulse due to this charge process and say that the impulse of such a slow discharge is a good approximation of the actual rapid discharge.

Let v be the discharge velocity corresponding to p , then from Eq. (1.43), we have

$$v = \sqrt{\frac{2 \gamma'}{\gamma' - 1} \frac{p}{\rho} \left[1 - \left(\frac{p_0}{p} \right)^{\frac{\gamma' - 1}{\gamma'}} \right]}$$

The impulse due to a discharge dm at this velocity is

$$dI = v \, dm \quad (12.7)$$

If m is the mass before the removal of dm , then the ratio of density in the chamber after the removal of dm to that before the removal is

$$\frac{m - dm}{m}$$

Similarly the pressure ratio is

$$\frac{p + dp}{p}$$

Since the process in the combustion chamber is isentropic, we have

$$\frac{p + dp}{p} = \left(\frac{m - dm}{m} \right)^\gamma$$

Hence, by neglecting infinitesimals of higher order, we obtain

$$\gamma \frac{dm}{m} = - \frac{dp}{p} \quad (12.8)$$

This shows that a discharge of dm will decrease the pressure in the chamber, as expected. Now $m = \rho V$ where V is the volume of the combustion chamber. Thus we can replace the dm in Eq. (12.7) completely by dp . The result is

$$dI = - \sqrt{\frac{2\gamma'}{\gamma' - 1} \frac{p}{\rho} \left[1 - \left(\frac{p_0}{p} \right)^{\frac{\gamma' - 1}{\gamma'}} \right]} \frac{1}{\gamma'} \rho V \frac{dp}{p} \quad (12.9)$$

To find the total impulse due to the discharge, we have to integrate dI for pressure variations from the initial pressure p_3 to the final pressure p_0 . Therefore

$$\begin{aligned} I &= \frac{1}{\gamma'} \sqrt{\frac{2\gamma'}{\gamma' - 1}} V \int_{p_0}^{p_3} \sqrt{\frac{p}{\rho} \left[1 - \left(\frac{p_0}{p} \right)^{\frac{\gamma' - 1}{\gamma'}} \right]} \frac{\rho}{p} dp \\ &= \frac{1}{\gamma'} \sqrt{\frac{2\gamma'}{\gamma' - 1}} (V \rho_3) \sqrt{\frac{p_3}{\rho_3}} \int_{p_0/p_3}^1 \sqrt{\frac{1}{\eta^{\frac{\gamma' - 1}{\gamma'}}} \left[1 - \left(\frac{p_0}{p_3} \right)^{\frac{\gamma' - 1}{\gamma'}} \frac{1}{\eta^{\frac{\gamma' - 1}{\gamma'}}} \right]} d\eta \end{aligned} \quad (12.10)$$

where $\eta = p/p_3$. But $V\rho_3$ is the total mass in the combustion chamber at the beginning of discharge, and $\left(\gamma' \frac{p_3}{\rho_3} \right)^{\frac{1}{2}}$ is the velocity of sound a_3 corresponding to the conditions in the combustion chamber at the end of combustion.

Thus if we call the "effective exit velocity" v_e , then

$$\frac{v_e}{a_3} = \frac{1}{\gamma'} \sqrt{\frac{2}{\gamma' - 1}} \int_{p_0/p_3}^1 \frac{1}{\eta^{\frac{\gamma' - 1}{\gamma'}}} \left[1 - \left(\frac{p_0}{p_3} \right)^{\frac{\gamma' - 1}{\gamma'}} \frac{1}{\eta^{\frac{\gamma' - 1}{\gamma'}}} \right]^{\frac{1}{2}} d\eta \quad (12.11)$$

The integral cannot generally be expressed in terms of elementary functions. However, well-known methods can be applied to yield series which are suit-

able for numerical computation. The results for $\gamma = \frac{4}{3} = 1.333$ are shown in Fig. 12.4*.

If we have an average mass rate flow of one unit per second, the average thrust is $l \cdot v_e$. This thrust is diminished by the intake momentum of $l \cdot v_o$ where v_o is the flight velocity. Thus the actual thrust for a mass flow of one unit per second is $l \cdot (v_e - v_o)$. If H is the heat value of the fuel per lb and η_b the combustion efficiency then the specific fuel consumption s in lb per hr per lb thrust is

$$s = \frac{3600 h}{778 H \eta_b (v_e - v_o)}$$

Substituting the value of h from Eq. (12.6) and with a slight reduction, we have

$$s = \frac{3600 a_3 \left(1 - \frac{p_2}{p_3}\right)}{778 H \eta_b \left[\frac{v_e - M_o \left(\frac{a_o}{a_3}\right)}{a_3}\right]} \frac{1}{\gamma'(\gamma' - 1)} \quad (12.12)$$

In this formula the ratio of sound velocities is given by

$$\left(\frac{a_3}{a_o}\right)^2 = \frac{\gamma' R' T_3}{\gamma R T_o} = \frac{C_p'}{C_p} \frac{\gamma' - 1}{\gamma - 1} \left(\frac{p_3}{p_2}\right) \left(\frac{T_1}{T_o}\right) \quad (12.13)$$

Therefore, the specific fuel consumption can easily be determined if we know the pressure ratio p_2/p_3 and the combustion efficiency η_b . For $C_p' = 0.276$ B.t.u. per lb per degree Fahrenheit, $C_p = 0.243$ B.t.u. per lb per degree Fahrenheit, $H = 18,700$ B.t.u. per lb, $\gamma' = 1.403$, $\gamma' = 1.333$, and $\eta_b = 95\%$, we have the results as shown in Fig. 12.5.

It is seen that with the fixed pressure ratio p_3/p_2 , the specific fuel consumption generally increases with increase in flight velocity. In other words, the increase in the effective exit velocity due to higher stagnation pressure at higher flight velocity is not sufficient to compensate for the loss due to intake momentum. It will be seen that this is also true for the turbojet.

4. Example of Actual Specific Consumption of Aeropulse

To compare our simple theory with the actual performance of an aeropulse, we shall use the test data** on the German engine for the flying bombs. Of course, for comparison with the theory, we have to use the specific fuel

*For this case, $\frac{v_e}{a_3} = \frac{6 \sqrt{6}}{7} \sqrt{1 - \left(\frac{p_o}{p_3}\right)^{\frac{1}{2}}} \left[1 - \frac{1}{5} \left(\frac{p_o}{p_3}\right)^{\frac{1}{2}} - \frac{4}{15} \left(\frac{p_o}{p_3}\right)^{\frac{1}{2}} - \frac{8}{15} \left(\frac{p_o}{p_3}\right)^{\frac{3}{4}}\right]$

**Memorandum Report "Twenty-Foot Wind Tunnel Tests on the Jet Unit of a German Robot Bomb (J B-2)", ENG.-51-6731-11, AAF, August 30, 1944

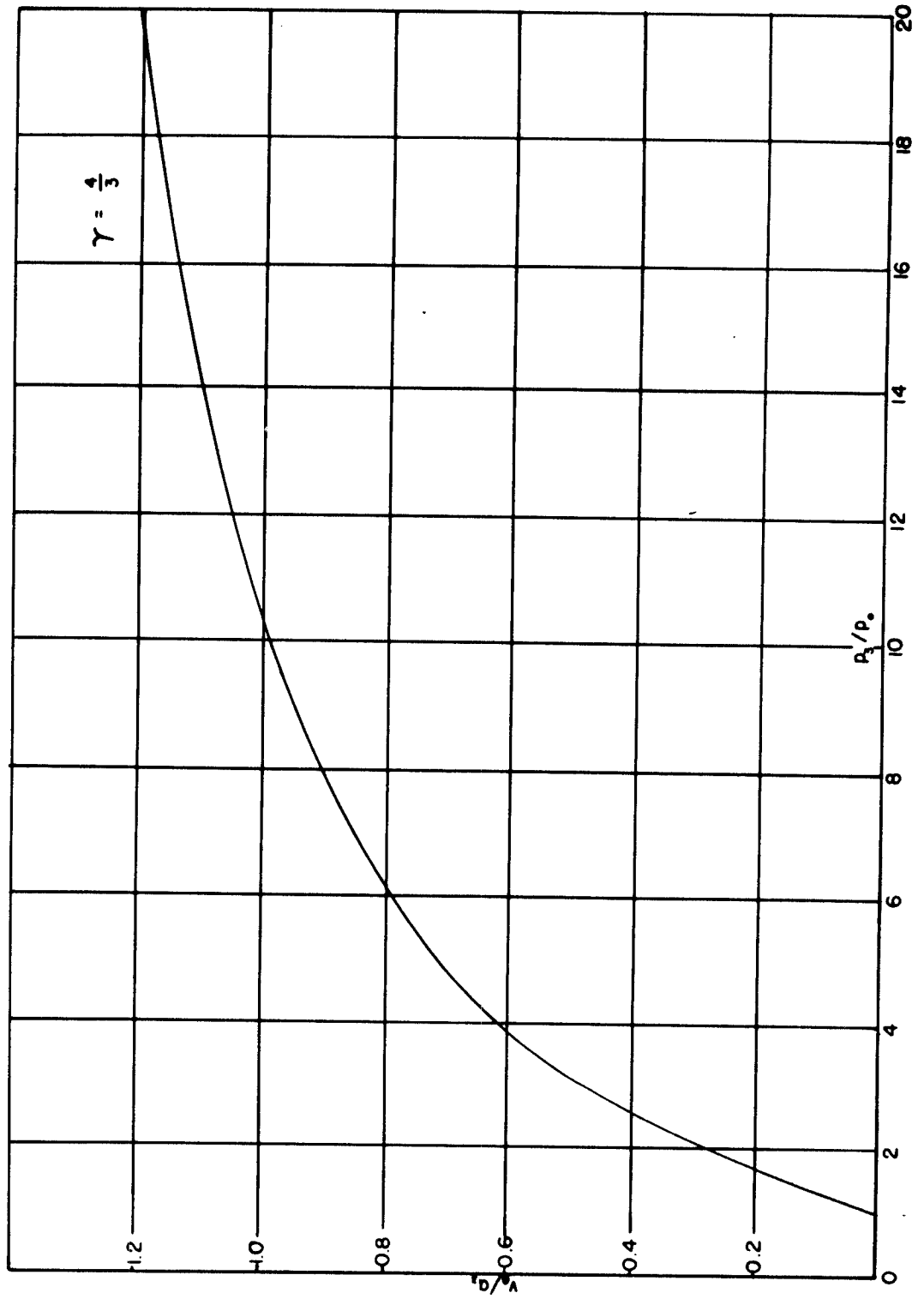

Fig. 12.4

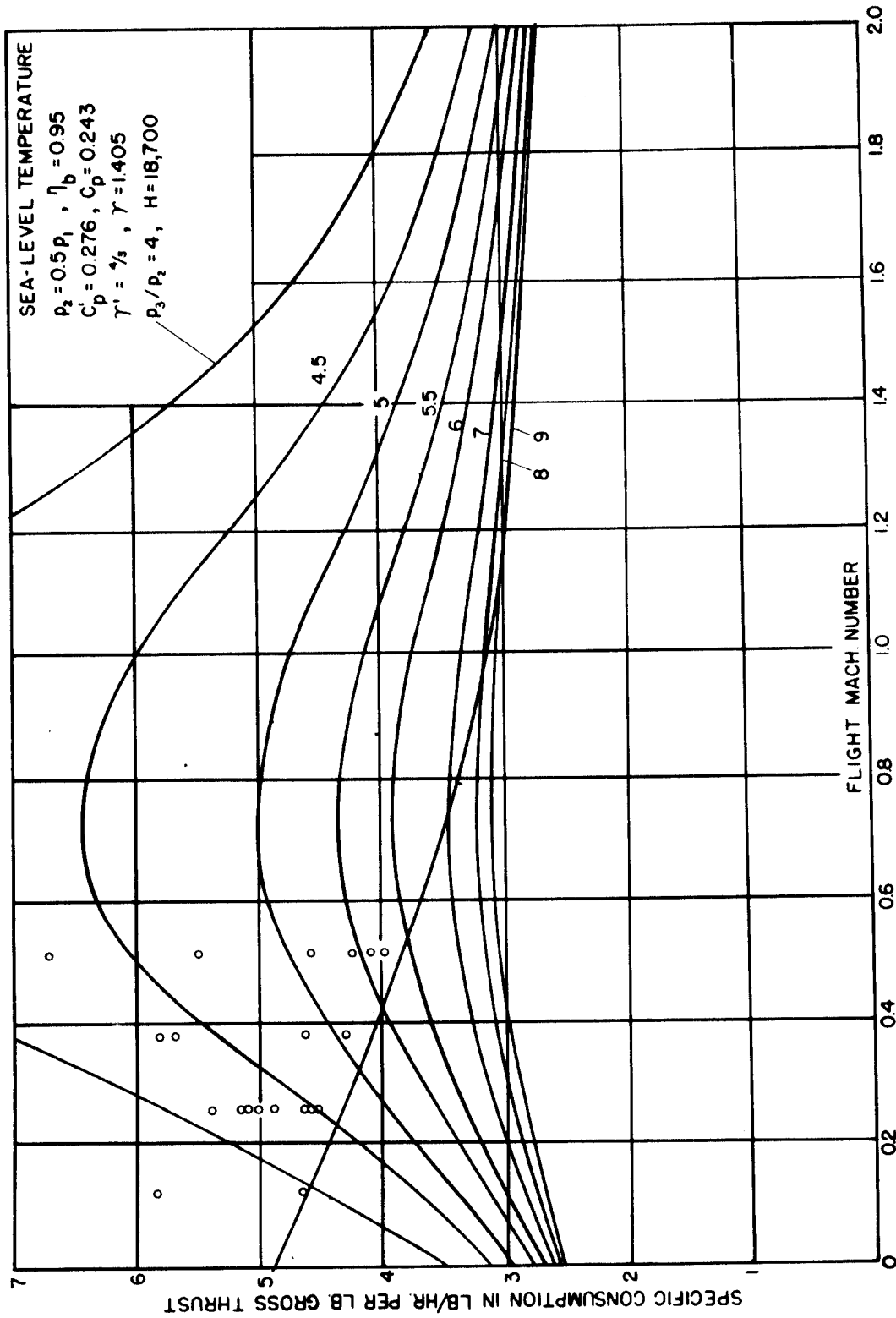

Fig. 12.5

consumption referred to the gross thrust, i.e., thrust not including the external drag of the duct. The gross thrust is obtained for the actual engine by adding the measured drag of the cold duct with the intake closed to the measured net thrust. The deduced specific fuel consumption is plotted in Fig. 12.5. At a given flight Mach number, or rather wind tunnel Mach number, various fuel injection pressures are used. These give the series of points shown. By increasing the amount of fuel, the thrust of the unit will increase due to higher explosion pressure. Higher explosion pressure gives better efficiency of expansion or lower specific fuel consumption. This is born out by the experiments.

Evidently, however, the combustion process is such that the amount of fuel which can be effectively burned is smaller at lower flight Mach numbers. Therefore, the explosion pressure is lower and the specific fuel consumption higher. At higher velocities, richer mixtures can be burned. In predicting the performance of an aeropulse of the German type at high flight velocities, it is interesting to estimate the highest possible explosion pressure ratio by rich mixture for a given fuel, say gasoline. As a first estimate, p_3/p_2 for gasoline is unlikely to exceed 9. This means that the specific consumption of this type of engine is unlikely to be lower than that given the heavy line in Fig. 12.5 for very high speeds. Hence the specific consumption of this type of aeropulse based on gross thrust is about 3 lbs per hr per lb thrust for high flight Mach numbers. If the specific consumption is based on the net thrust produced by the unit, this value must be increased, as can be inferred from Fig. 12.6. Altitude has only slight influence on the specific consumption. Thus Fig. 12.6 can also be used to estimate the fuel rate at higher altitudes.

5. Frequency of Pulsation and Thrust of an Aeropulse

Our simple theory, based upon a quasi-steady discharge, fails completely in predicting the frequency which is directly connected with the non-steady pulsating flow. In order to have an estimate of the frequency, we shall adopt another very simple picture of operation. We shall assume the explosion pressure ratio p_3/p_2 to be very nearly equal to unity. In other words, we shall assume the pressure amplitude to be very small and then calculate the frequency by the elementary considerations applicable to small pressure amplitudes, i.e., the sound vibration in a pipe. We then say that the frequency so calculated for very small pressure amplitudes should be representative of that for large pressure amplitudes.

Consider the aeropulse as an organ pipe closed at the spring valve cord end and open at the other. Then the pulsation in the pipe can be considered as a quarter wave length oscillation with a maximum pressure amplitude at the closed end and a zero pressure amplitude but maximum velocity amplitude at the open end, as shown by Fig. 12.7. If a^* is the velocity of sound propagation and L the length of the pipe, the frequency f of oscillation is

$$f = \frac{a^*}{4L} \quad \text{cycles per second} \quad (12.14)$$

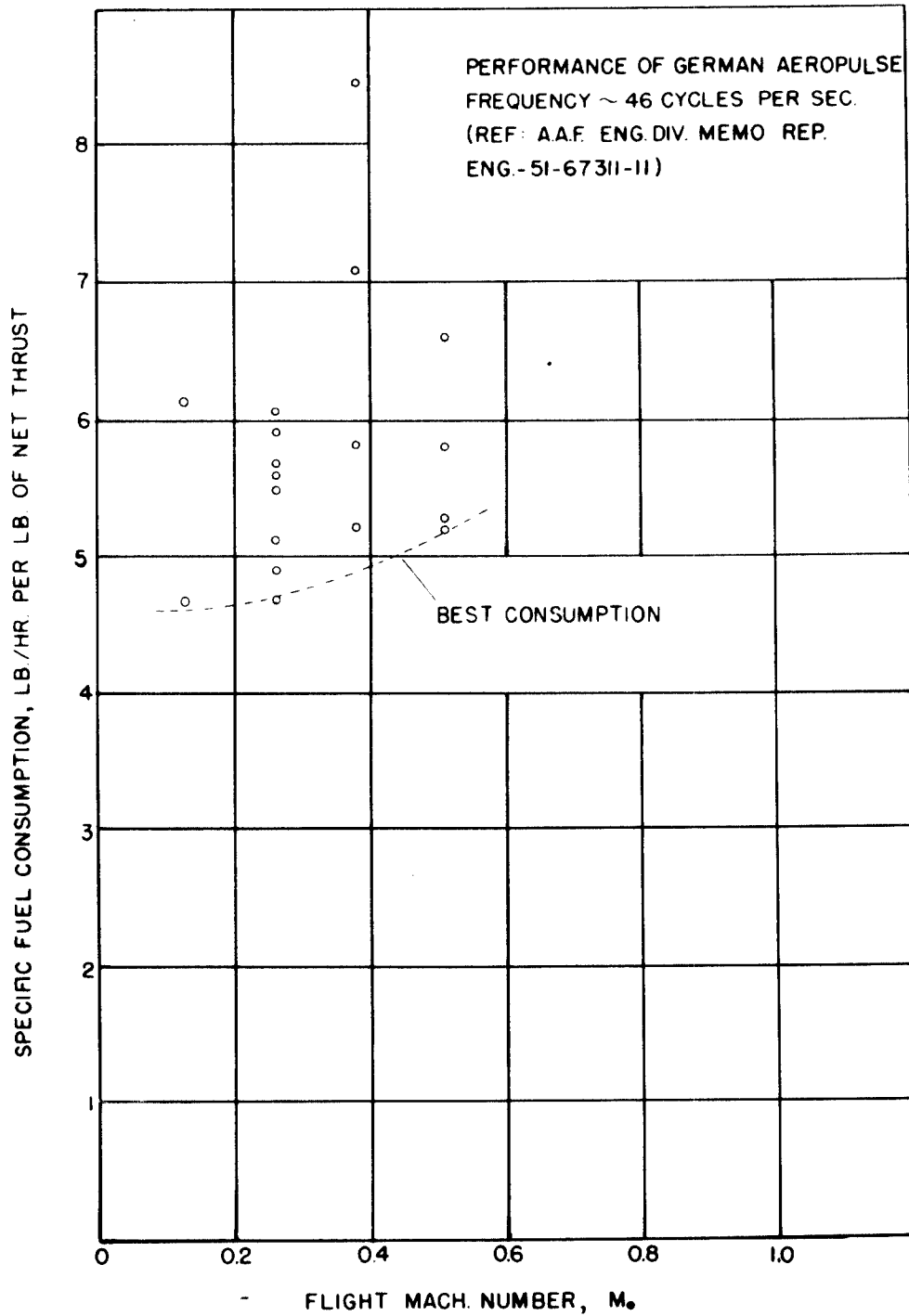

Fig. 12.6

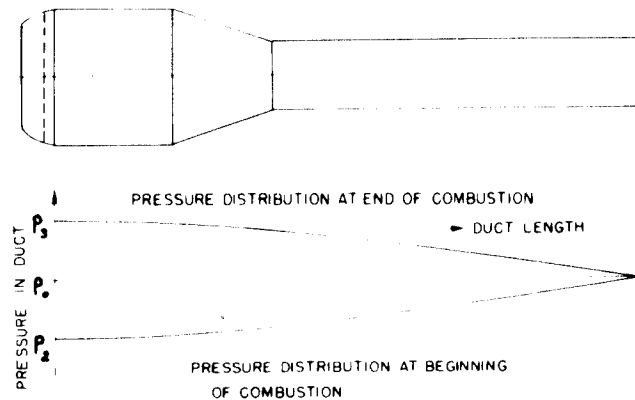

Fig. 12.7

For the application to the aeropulse, we must use a^* corresponding to the mean condition of the flow in the duct. Since the temperature at end of expansion in the duct is

$$T_3 \left(\frac{p_0}{p_3} \right)^{\frac{\gamma'-1}{\gamma'}}$$

the mean value a^* for the velocity of sound is

$$\begin{aligned} a^* &= a_3 \frac{1}{2} \left[1 + \left(\frac{p_0}{p_3} \right)^{\frac{\gamma'-1}{2\gamma'}} \right] \\ &= a_0 \left(\frac{a_3}{a_0} \right)^{\frac{1}{2}} \left[1 + \left(\frac{p_0}{p_3} \right)^{\frac{\gamma'-1}{2\gamma'}} \right] \end{aligned} \quad (12.15)$$

For instance, if $p_3/p_2 = 4$ or $p_3/p_0 = 2$, $\gamma' = \frac{4}{3}$ and $M_0 = 0$, Eqs. (12.13) and (12.15) give

$$a^* = 1.849 a_0$$

For the German aeropulse for flying bombs, $L = 10.3$ ft., and for standard sea-level conditions, $a_0 = 1120$ ft/sec. Then Eq. (12.14) gives $f = 50.1$ cycles per second. This checks very well with the measured value of 46 cycles per second at the low fuel rate. Most of the difference is probably accounted for by the combustion period which, although short, is not negligible. At higher fuel rates, the combustion period is lengthened, which tends to lower the frequency. Experiments show that the frequency at high fuel rates is actually slightly lower in spite of the fact that sound velocity is higher at higher temperature due to the richer mixture.

The average thrust of the aeropulse depends on the rate of air flow and the mixture ratio. The rate at which the air is taken into the duct per second is, in turn, dependent upon the charge per cycle and the number of cycles per second. All three factors, however, are interrelated. For instance, if the cycles per second are very large, the charge pressure in the chamber will be low, due to the rapid acceleration necessary to push the air in the chamber. In other words, the charge per cycle tends to decrease as the frequency is increased. Furthermore, the combustion process also tends to limit the mixture ratio that could be effectively used at lower values if the frequency were increased as the combustion time was shortened. Thus the average thrust of the aeropulse, being an increasing function of the product of all three factors, has a maximum with respect to the rate of fuel injection and the frequency, or the length of the tail pipe. The actual prediction of the thrust of an aeropulse is thus rather complicated. The situation is very similar to the case of the reciprocating gasoline engine. The calculation of horse-power output of the reciprocating engine is generally based upon empirical data, as the effects of volumetric efficiency or breathing capacity and combustion conditions are very difficult to calculate. Similarly, the design of an aeropulse must be based upon a wealth of well-performed experiments giving the fundamental relation between frequency, mixture ratio and thrust.

The measured net thrust of the German aeropulse is plotted in Fig. 12.8 against flight Mach number for sea-level conditions. The various points for a given Mach number are the results of different fuel injection rates. Higher fuel rates give, of course, larger thrust until a maximum thrust corresponding to a given flight Mach number is reached. Further increase in fuel rate results in poor burning and a consequent reduction in thrust. The highest thrust in the figure corresponds roughly to these maximum values.

If the ratio of pressures at the beginning of the combustion to those at the end of combustion is maintained and the frequency and flight Mach number kept the same, the thrust of the engine will be directly proportional to the atmospheric pressure, as everything can then be referred to the atmospheric pressure. Thus, if F' is the thrust corresponding to p_0' and F for p_0 , then under the conditions stated

$$F' = F \left(\frac{p_0'}{p_0} \right) \quad (12.16)$$

Actually the ratio of pressures of combustion and frequency both depend upon the mixture ratio and atmospheric temperature. The fact that the atmospheric temperature enters the relation can be seen by the following reasoning. If the atmospheric temperature is low, the temperature at the beginning of the combustion will also be low, with everything else the same. Now, keeping the mixture ratio and combustion efficiency the same, the heat due to combustion per unit mass of gas and the temperature rise of the gas will be the same, but the ratio of absolute temperature and, hence, the pressure ratio will be higher due to lower temperature at the start of the combustion. This fact tends to give higher thrust at altitudes other than those calculated from Eq. (12.16). However, the more sluggish combustion at lower

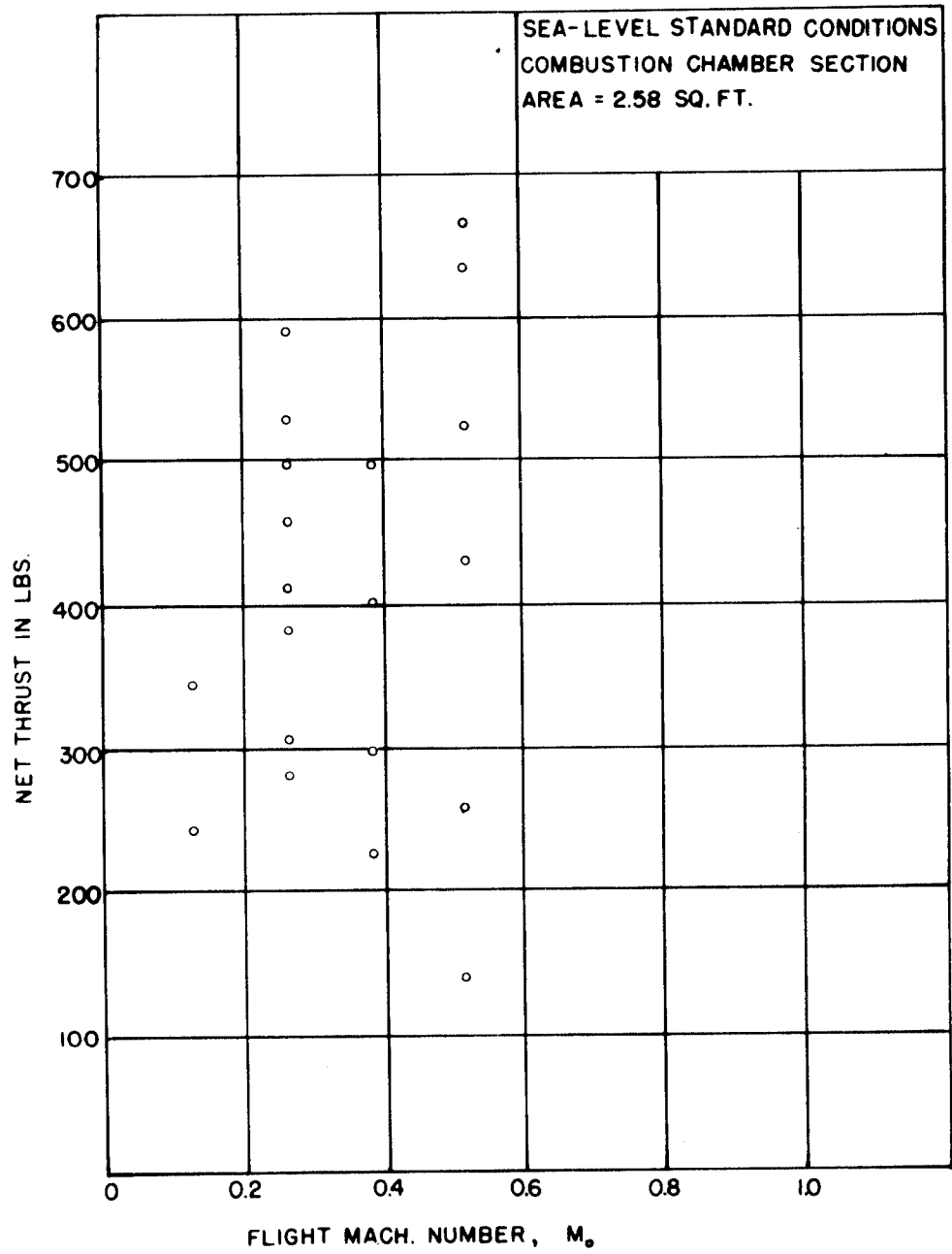

Fig. 12.8

pressures, and hence lower frequencies, may balance this tendency. Thus, for lack of more accurate information, Eq. (12.16) can be used to calculate the altitude performance of the aeropulse, provided the mixture ratios at two altitudes are the same.

If the mixture ratio and the frequency are maintained, then the thrust is directly proportional to the size or the sectional area of the combustion chamber. Since Eq. (12.14) shows that frequency is a function of the distance between the air flow valve and the exit of the duct, this distance must be kept the same for the same frequency. Actually the change in the flow condition with change in combustion chamber size will produce a small deviation from this simple rule. However, it is certain that, with increasing thrust, the aeropulse engine will become less slender in overall dimensions.

To compare the thrust output of the aeropulse with other power plants, it is advantageous to express the net thrust F_{net} in terms of a thrust coefficient defined as

$$C_F = \frac{F_{net}}{\frac{1}{2} \rho_0 v_0^2 A} \quad (12.17)$$

where A is the combustion chamber cross-sectional area. The maximum value of the thrust coefficient is given in Fig. 12.9 based upon the test data on the German aeropulse. At static conditions, $v_0 = 0$, but the aeropulse has a static thrust, thus $C_F \rightarrow \infty$. However, the coefficient decreases rapidly with increase in velocity as shown by Fig. 12.9.

6. The Overall Performance of Aeropulse and Possibly Developments

The overall performance of a power plant can, perhaps, be judged by the total weight, i.e., the sum of the power plant weight plus the fuel weight. Those power plants which have high fuel consumption must be light in order to compete with power plants which have low fuel consumption. The weight of the German aeropulse is shown in the following table:

Weight Breakdown of German Aeropulse

| | |
|---------------------------------------|--------|
| Engine Dry | 287 lb |
| Mounting and Their Fairings | |
| Forward Yoke and Vertical Supports | 47 |
| Rear Support, Integral with Fin | |
| Nose Fairing | 28 |
| Engine Accessories | |
| Control valves, etc. | 18 lb |
| Fuel Piping System and Fuel in System | 12 |
| | 392 lb |

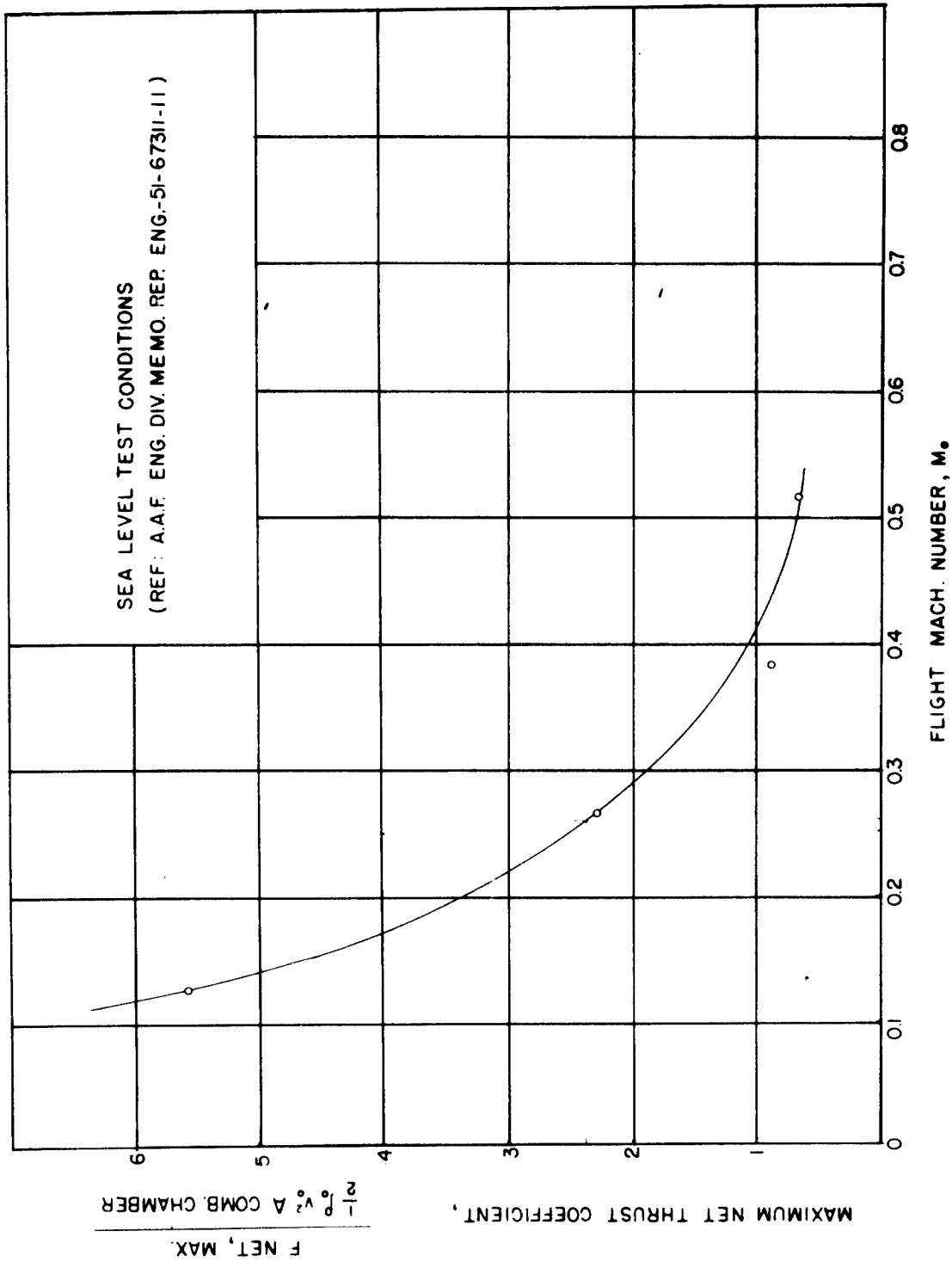

Fig. 12.9

Although this engine gives about 900 lb gross thrust at 400 mph, or approximately 0.3 lb of dry engine per lb of thrust, it is not much lighter than the new turbojet units. Of course, it is much simpler in construction, and hence cheaper, than the turbojets. On the other hand, its fuel consumption of about 4 lb per hr per lb gross thrust at 400 mph is much higher than for turbojets which have a specific consumption between 1.1 to 1.3 lb per hr per lb gross thrust.

However, as the size of the aeropulse increases, the unit will be less slender (see Section 5) and a reduction in unit weight could thus be achieved. Furthermore, by using lighter materials, the structural weight could also be considerably decreased. To reduce the fuel consumption, we must raise the combustion pressure and reduce the drag of the unit. The combustion pressure can be raised by a more violent burning. This can be realized by a synchronized injection of fuel at the most advantageous point of the cycle instead of the present almost continuous injection during the whole cycle. Perhaps other fuels should also be explored with a view to inducing more rapid combustion. To reduce the drag of the power plant, we can design the duct so that it forms a single unit with the fuselage of the aircraft. All these suggestions must, of course, be carefully checked by both experiments and theoretical analysis.

We have stated that, due to the bad diffuser shape, the pressure recovery after the valve is very small and is neglected in our simplified analysis. This means that there is a big throttling loss across the inlet valve. In fact, the present German aeropulse has an effective opening for air flow which is only approximately 60% of the frontal area of the inlet valve. This loss should be eliminated in order to improve the efficiency and lower the fuel consumption. Therefore, it is suggested that we dispense with the valve and rely on the resonance effect of the air and gas column to control the flow. Of course, if the velocity of air flow in the duct is small, part of the combustion products will escape to the entrance, then the effective thrust of the unit will be reduced. Therefore, flight velocity is essential to the successful operation of a valveless aeropulse.* Furthermore, if the flight velocity is supersonic, the explosion pressure wave due to combustion, travelling with velocities only slightly higher than sonic, cannot reduce or change the velocity of flow in front of the wave. Thus all discharge goes to the rear exit. It seems, therefore, that the valveless aeropulse is especially promising for supersonic flight.

*Applied Mathematics Group, New York University, "Note on Valveless Aero - and Hydropulse Motors", AMP Memo 137, IM, AMG-NYU, No. 120, May, 1945

PROBLEMSProblem 12.1

Estimate the length and the diameter of the combustion chamber for an aeropulse of the same type as the German engine for the flying bomb, assuming the same frequency. The required performance at maximum thrust is 1400 lb net thrust at 10,000 ft. standard altitude and 400 mph. What is the fuel consumption in lb per hr? The German engine has a length of 10.3 ft and combustion chamber section area of 2.58 sq. ft. and weighs approximately 300 lbs. If the weight of such engines is proportional to the surface area of the duct, what will be the weight of the new engine designed? What is the weight per lb of net thrust?

Problem 12.2

If the throttling loss can be completely eliminated and $p_2 = p_1$, what is the calculated specific fuel consumption in lb per hr per lb of gross thrust at flight Mach number 2 with $p_3/p_2 = 9$, assuming the same constants as used for Fig. 6.5? The altitude of flight is 40,000 ft. standard conditions.

California Institute of Technology, Pasadena.

Daniel Guggenheim Aeronautical Laboratory

JET PROPULSION

A REFERENCE TEXT PREPARED BY
THE STAFFS OF THE GUGGENHEIM
AERONAUTICAL LABORATORY AND
THE JET PROPULSION LABORATORY,
GALCIT. CALIFORNIA INSTITUTE
OF TECHNOLOGY FOR THE

AIR TECHNICAL SERVICE COMMAND

This document contains information affecting
the National Defense of the United States,
within the meaning of the Espionage Act
U.S.C. 50:31 and 32. Its transmission or
the revelation of its contents in any manner
to an unauthorized person is prohibited by
law.

RESTRICTED

1946

10/10/46